

**Quick Model Selection:**

- Step 1: Check your **Voltage**
- Step 2: Check your **Frequency**
- Step 3: **Select model based on HVAC unit rated RLA (Run Load Amperage)**

SureStart US Models				
Model Number	Voltage	Frequency (Hz)	RLA Rating (From Unit Product Data)	Phase
SS0B12-20SN	115	50/60	12 - 20	Single
SS1B08-16SN	230	50/60	8 - 16	
SS1B16-32SN	230	50/60	16 - 32	
SS2A04-28SN	208-230	50/60	4 - 28	Three
SS3A04-27SN	380	50/60	4 - 27	
SS5A04-27SN	460	60	4 - 27	

**Quick HVAC Application Criteria**

Compressor Types	Requirements
Scroll (1&2-stage)	None - Internal pressure equalization standard
Reciprocating	Bleed/equalizing TXV - Pressure equalization required
Rotary & Screw	Bleed/equalizing TXV - Pressure equalization required

**Application Notes:**

- AC drive compressor motor applications only
- PSC Motors only - SureStart cannot be installed on units with Variable Speed compressors
- Motor start time < 0.5 secs
- Inlet and Discharge pressures must be equalized on compressor motor at startup

**Back-up Generator & Solar (PV) Considerations - 1-Phase**

Existing Generator/Solar Systems	Drastically lowered LRA potentially allows connecting HVAC to existing generator/solar inverter system
New Generator/Solar Systems	Drastically lowered LRA potentially allows generator/solar inverter sizing flexibility (smaller) when designing new system including HVAC

**Quick Installation Information**

**1-Phase Connections**

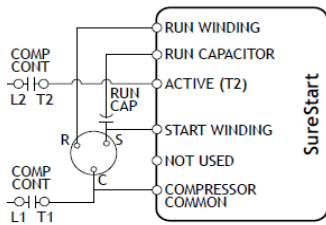

230V with Two Pole Contactor

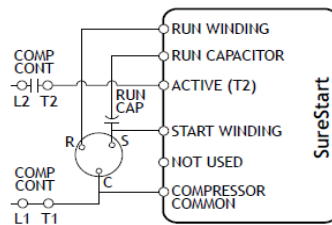

115V/230V with Single Pole Contactor

**3-Phase Connection**

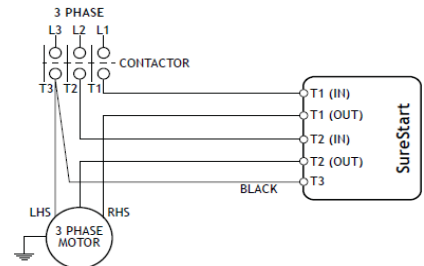

**Approved Mounting Positions**

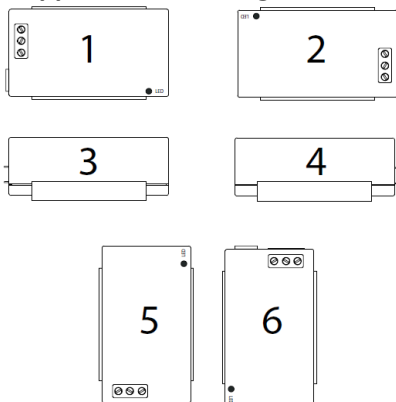

*SureStart designed for service/control/electrical compartment mounting.*

(Bracket mounting screws and wiring leads (1-ph) included)

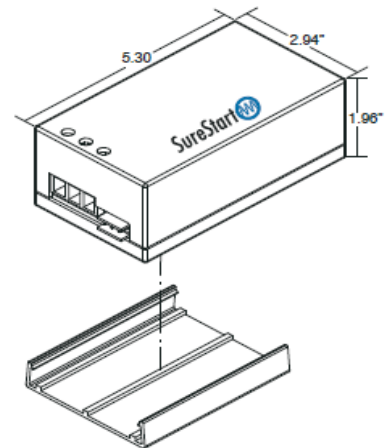

# SureStart HVAC Application Benefit Summary

*SureStart measures the characteristics of a motor and then optimizes electrical input over several start cycles until the starting current, or Locked Rotor Amps (LRA) is reduced by 50 – 70%. Reduced LRA leads to significantly decreased voltage fluctuation throughout the circuit, and reduces both electrical and mechanical wear on the entire system.*

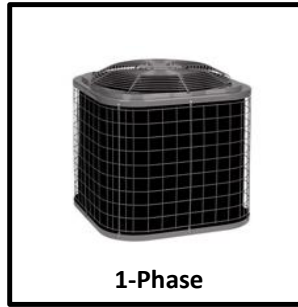

1-Phase



3-Phase

**Reduces compressor LRA/starting current**  
**Reduces compressor starting torque**

- Eliminates light flicker/dimming on compressor startup
- Eliminates power interruption to sensitive electronics
- Quieter compressor startup
- Low voltage compressor starting/stalling protection
- Protection from scroll compressor reversal
- Protection from phase reversal: 3-Phase
- Reduces stress on compressor at startup
- Power interruption time delay protection

**Backup generator application flexibility**  
**Solar inverter application flexibility**  
**Delivers HVAC conformance to utility peak current regulations**  
**Supports meeting utility incentive program requirements**  
**Helps stabilize utility grid voltage**  
**Contributes to overall utility power quality**

**Up to 70%**  
**Up to 30%**

Not Applicable

**Up to 40%**  
**Up to 70%**

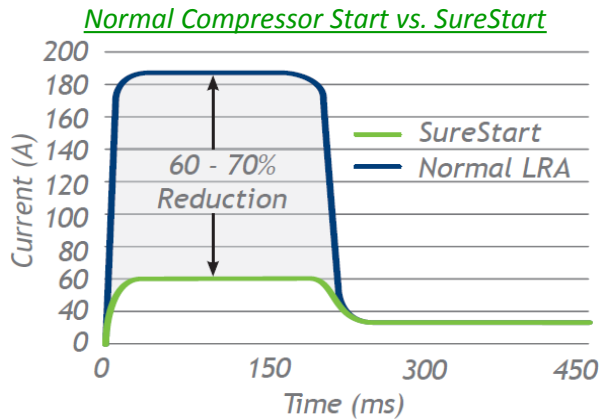
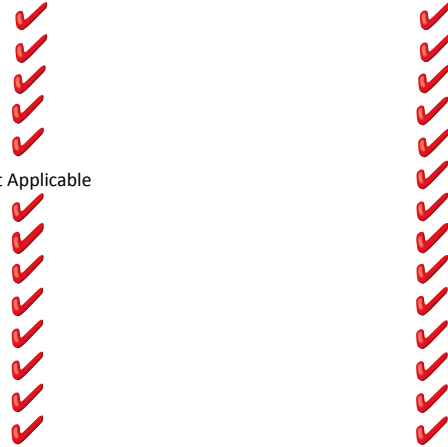

**Gen-Pro**  
**630-240-9139**  
[www.gen-pro.biz](http://www.gen-pro.biz)  
 Generac Dealers PROMO Code: "GENDEAL"

## SureStart HVAC "Connection"

**You can find SureStart in most HVAC applications where lower in-rush currents (LRA) are required!**

